

• **Anwendung**

Für den Einsatz im allgemeinen Maschinen-, Apparate-, Behälter- und Rohrleitungsbau sowie in der Chemie-Verfahrenstechnik und im Lebensmittelbereich sehr gut geeignet.

• **Service intended**

These rugged thermometers are well suited for machine and apparatus engineering, pressure vessels and piping as well as for environments in chemical process and food industry.

• **Utilisation**

Ces thermomètres sont très bien adaptés aux utilisations dans la construction de machines, d'appareils, de tuyauterie et réservoirs ainsi que dans la chimie, technologie des procédés industriels et dans l'industrie alimentaire.



Technische Daten	Technical Data	Caractéristiques techniques
<b>Anschlusskopf</b>	<b>Connection head</b>	<b>Tête de raccordement</b>
nach DIN 43729, Form B bzw. A aus Alu Kabeleinführung : M20 x 1,5 mm	per DIN 43729, form B or A, aluminium Cable entry: M20 x 1,5 mm	Forme B ou A selon DIN 43729, en aluminium Presse-étoupe: M20 x 1,5 mm
<b>Schutzart</b>	<b>Protection class</b>	<b>Degré de protection</b>
IP 54 nach EN 60529	IP 54 per EN 60529	IP 54 selon EN 60529
<b>Anschlusssockel</b>	<b>Connection socket</b>	<b>Socle de raccordement</b>
Keramik	Ceramic	Céramique
<b>Messeinsatzrohr</b>	<b>Measuring insert tube</b>	<b>Tuyau de éléments de rechange</b>
Inconel 600 2.4816	Inconel 600 2.4816	Inconel 600 Ni15Fe
<b>Schutzrohr</b>	<b>Thermowell</b>	<b>Doigt de gant</b>
Stahl 1.4841 bzw. 1.4749, bzw. Keramik	Steel 446 / Stainless steel 316Ti, or ceramics	Acier Z10C24 / acier inox Z6 CNDT 16, ou céramique
<b>Messorgan*</b>	<b>Measuring element*</b>	<b>Élément la mesure*</b>
Thermoelement (Thermopaar) nach DIN EN 60584 Fe-CuNi Typ (J) NiCr-Ni Typ (K) Pt10Rh-Pt Typ (S) Pt30Rh-Pt6Rh Typ (B) Pt13Rh-Pt Typ (R)	Thermocouple per DIN EN 60584 Fe-CuNi type (J) NiCr-Ni type (K) Pt10Rh-Pt type (S) Pt30Rh-Pt6Rh type (B) Pt13Rh-Pt type (R)	Thermocouple selon DIN EN 60584 Fe-CuNi type (J) NiCr-Ni type (K) Pt10Rh-Pt type (S) Pt30Rh-Pt6Rh type (B) Pt13Rh-Pt type (R)
<b>Temperaturbereiche</b>	<b>Temperature range</b>	<b>Plage de températures</b>
siehe Seiten 19.0403 - 19.0405	see pages 19.0403 - 19.0405	voir pages 19.0403 - 19.0405
<b>Genauigkeitsklasse</b>	<b>Accuracy class</b>	<b>Tolérance</b>
Klasse 2 nach DIN EN 60584 = ± 2,5°C	Class 2 per DIN EN 60584 = ± 2,5°C	Classe 2 selon DIN EN 60584 = ± 2,5 °C



**Ergänzungen**

siehe Seiten 11.3208 - 11.3406

**Technische Informationen**

siehe ab Seite 19.0401



**Optional extras**

see pages 11.3208 - 11.3406

**Technical information**

see from page 19.0401



**Options**

voir pages 11.3208 - 11.3406

**Informations techniques**

voir à partir de la page 19.0401

\* Gewünschtes Messelement (Thermoelementtyp) bei der Bestellung bitte angeben!

\* Preferred measuring element (thermocouple type), please specify when ordering!

\* Désiré élément (de type thermocouple) la mesure, s'il vous plaît préciser à la commande!

**T21**  
**T22**

**Thermoelemente**  
**Thermocouples**  
**Thermocouples**

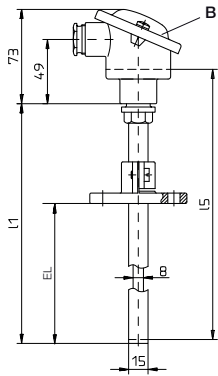

**T21.U.4**

mit Schutzrohr Form A nach DIN 43763  
with thermowell form A DIN 43763  
avec doigt de gant forme A selon DIN 43763  
<600°C = 1.4571, 316Ti, Z6 CNDT 17-12  
>600°C = 1.4749, AISI446, Z6 CNDT 16

<b>T21.U.4</b> DIN 43764			Messeinsatz Measurig inserts Eléments de rechange		
l1 mm	Bestell-Nr. Order-N°. N° de commande		l5 mm	Bestell-Nr. Order-N°. N° de commande	
	1x Fe-CuNi -200 - +600°C	1x NiCr-Ni -200 - +800°C		1x Fe-CuNi -200 - +600°C	1x NiCr-Ni -200 - +800°C
200	111215	111232	225	118501	416498
250	111216	111233	275	118502	416499
290	111217	111234	315	118503	416500
350	111218	111235	375	118504	416479
380	111219	111236	405	118505	416501
410	111220	111237	435	118507	416502
500	111221	111238	525	118508	416503
530	111222	111239	555	118509	416504
630	111223	111240	655	118510	416505
710	111224	111241	735	118511	416506
800	111225	111242	825	118512	416507
1000	111226	111243	1025	118979	115817
1250	111227	111244	1275	118461	115818
1400	111228	111245	1425	118462	115819
1600	111229	111246	1625	118463	115820
1800	111230	111247	1825	118464	115821
2000	111231	111248	2025	118465	115822

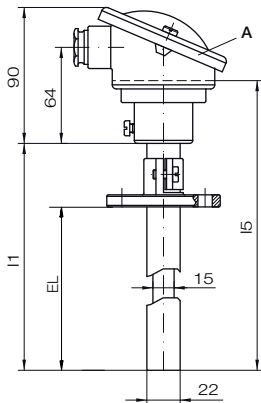

**T22.U.4**

mit Schutzrohr Form A nach DIN 43763, 1.4749  
with thermowell form A DIN 43763, 316Ti  
avec doigt de gant forme A selon DIN 43763, Z6 CNDT 16

<b>T22.U.4</b> DIN 43733			Messeinsatz Measurig inserts Eléments de rechange		
l1 mm	Bestell-Nr. Order-N°. N° de commande		l5 mm	Bestell-Nr. Order-N°. N° de commande	
	1xFe CuNi -200...+600 °C	1xNi CrNi -200...+1150 °C		1xFe CuNi -200...+600 °C	1xNi CrNi -200...+1150 °C
500	416961	416977	520	417100	417104
710	416962	416978	730	118470	417110
1000	416963	416979	1020	417112	417116
1400	416964	416980	1420	417118	417122

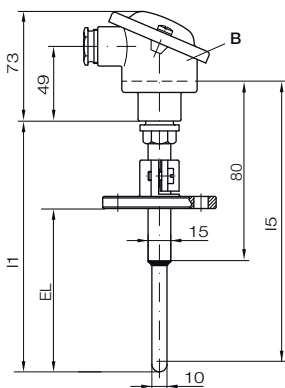

**T22.U.3**

mit Schutzrohr Form A, C 799/KER 710  
with thermowell form A, C 799/KER 710  
avec doigt de gant forme A, C 799/KER 710

<b>T22.U.3</b> DIN 43733			Messeinsatz Measurig inserts Eléments de rechange		
l1 mm	Bestell-Nr. Order-N°. N° de commande		l5 mm	Bestell-Nr. Order-N°. N° de commande	
	1x Pt10Rh-Pt 0-1300 °C	1x Pt30Rh-Pt6Rh 600-1400 °C		1x Pt10Rh-Pt 0-1300 °C	1x Pt30Rh-Pt6Rh 600-1400 °C
130	415984	416000	194	415968	415976
200	415985	416001	264	415969	415977
300	415986	416002	369	415970	415978
450	415987	416003	514	415971	415979

Stand: 25. 10. 2023

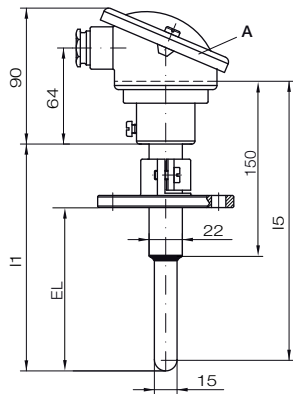

T22.U.2

mit Schutzrohr Form A, C 799/KER 710  
with thermowell form A, C 799/KER 710  
avec doigt de gant forme A, C 799/KER 710

T22.U.2 DIN43733				Messeinsatz Measurig inserts Eléments de rechange			
l1 mm	Bestell-Nr. Order-N° N° de commande			l5 mm	Bestell-Nr. Order-N° N° de commande		
	1x NiCr-Ni 0-1200°C	1x Pt10Rh-Pt 0-1300°C	1xPt30Rh-Pt6Rh 600-1400°C		1x NiCr-Ni 0-1200°C	1x Pt10Rh-Pt 0-1300°C	1xPt30Rh-Pt6Rh 600-1400°C
500	415876	415892	415908	520	416946	416948	416952
710	415877	415893	415909	730	416992	416994	416998
1000	415878	415894	415910	1020	417002	417004	417008
1400	514879	415895	415911	1420	471013	417015	417019

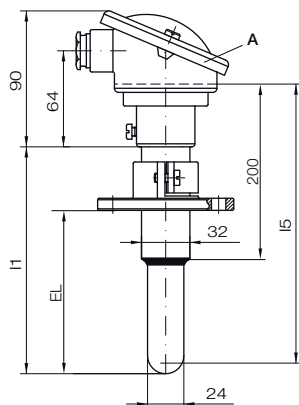

T22.U.1

mit Schutzrohr Form A, C 799/KER 710  
with thermowell form A, C 799/KER 710  
avec doigt de gant forme A, C 799/KER 710

T22.U.1 DIN43733				Messeinsatz Measurig inserts Eléments de rechange			
l1 mm	Bestell-Nr. Order-N° N° de commande			l5 mm	Bestell-Nr. Order-N° N° de commande		
	1x NiCr-Ni 0-1200°C	1x Pt10Rh-Pt 0-1300°C	1xPt30Rh-Pt6Rh 600-1400°C		1x NiCr-Ni 0-1200°C	1x Pt10Rh-Pt 0-1300°C	1xPt30Rh-Pt6Rh 600-1400°C
500	415924	415940	415956	520	417023	417025	417029
710	415925	415941	415957	730	417038	417040	417044
1000	415926	415942	415958	1020	417048	417050	417054
1400	415927	415943	415959	1420	417058	417060	417064

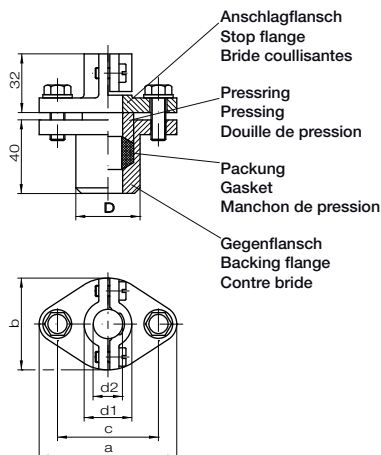

Anschlagflansch DIN 43734 mit Gegenflansch Stop flanges DIN 43734 with backing flanges Brides coulissantes DIN 43734 avec contre brides								
für Halterrohr for protection tube pour diamètre	a	b	c	d1	d2	D	Anschlagflansch Stop flanges Brides coulissante	Gegenflansch Backing flanges Contre brides
mm								
15	75	50	55	26	16	35	110843	415067
22	90	65	70	33	23	40	110844	415068
24				35	25	45	110845	415069
32				43	33	50	110846	415070

Stand: 25. 10. 2023

**T21  
T22**

**Thermoelemente  
Thermocouples  
Thermocouples**

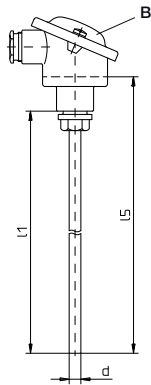

**T21.U.9**

ohne zusätzliches Schutzrohr<sup>1)</sup>  
without thermowell<sup>1)</sup>  
sans doigt de gant<sup>1)</sup>

<600°C = 1.4571, 316Ti, Z6 CNDT 17-12  
>600°C = Inconel 600®, 2.4816, Ni15Fe

T21.U.9 DIN 43769			Messeinsatz Measurig inserts Éléments de rechange			
l1 mm	Bestell-Nr. Order-N° N° de commande		l5	d	Bestell-Nr. Order-N° N° de commande	
	1x Fe-CuNi -200 - +600°C	1x NiCr-Ni -200 - +800°C			mm	
150	111171	111189	175	6	118473	115803
200	111172	111190	225		118483	115805
250	111173	111191	275		118486	115806
290	111174	111192	315		118487	115807
350	111175	111193	375		118489	115808
380	111176	111194	405		118490	115809
410	111177	111195	435		118492	114811
500	111178	111196	525		118495	115812
530	111179	111197	555		118496	115813
630	111180	111198	655		118497	115814
710	111181	111199	735		118498	115815
800	111182	111200	825		118499	115816
1000	111183	111201	1025	118979	115817	
1250	111184	111202	1275	8	118461	115818
1400	111185	111203	1425		118462	115819
1600	111186	111204	1625		118463	115820
1800	111187	111205	1825		118464	115821
2000	111188	111206	2025		118465	115822

<sup>1)</sup> Quetschringverschraubungen und Kugel- Quetschdichtungen siehe Seite: 11.3402  
Compression fittings and ball compression seals see page: 11.3402  
Raccord coulissant et Joint sphérique à compression: 11.3402

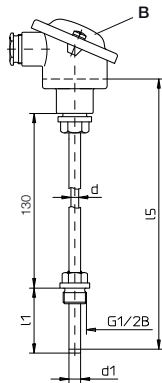

**T21.U.5**

mit Schutzrohr Form B nach DIN 43772, 1.4571  
with thermowell form B DIN 43772, 316Ti  
avec doigt de gant forme B selon DIN 43772, Z6 CNDT 17-12

T21.U.5 DIN 43765			Messeinsatz Measurig inserts Éléments de rechange				
l1 mm	d1	Bestell-Nr. Order-N° N° de commande		l5	d	Bestell-Nr. Order-N° N° de commande	
		1x Fe-CuNi -200 - +600°C	1x NiCr-Ni -200 - +800°C			mm	
65	9	111249	111269	220	6	118476	115804
70		111250	111270	225		118483	115805
120		111251	111271	275		118486	115806
160		111252	111272	315		118487	115807
220		111253	111273	375		118489	115808
250		111254	111274	405		118490	115809
275		111255	111275	430		118491	115810
280		111256	111276	435		118492	115811
370		111257	111277	525		118495	115812
400		111258	111278	555		118496	115813
500		111259	111279	655		118497	115814
580		111260	111280	735		118498	115815
670	111261	111281	825	118499	115816		
870	111262	111282	1025	118979	115817		
1120	111263	111283	1275	8	118461	115818	
1270	111264	111284	1425		118462	115819	
1470	111265	111285	1625		118463	115820	
1670	111266	111286	1825		118464	115821	
1870	111267	111287	2025		118465	115822	

Stand: 25. 10. 2023

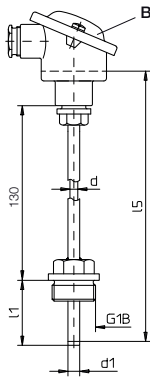

**T21.U.6**

mit Schutzrohr Form C nach DIN 43772, 1.4571  
with thermowell form C DIN 43772, 316Ti  
avec doigt de gant forme C selon DIN 43772, Z6 CNDT 17-12

T21.U.6 DIN 43766				Messeinsatz Measurig inserts Eléments de rechange			
l1	d1	Bestell-Nr. Order-N° N° de commande		l5	d	Bestell-Nr. Order-N° N° de commande	
mm		1x Fe-CuNi -200 - +600°C	1x NiCr-Ni -200 - +800°C	mm		1x Fe-CuNi -200 - +600°C	1x NiCr-Ni -200 - +800°C
65	11	111289	111309	220	6	118476	115804
70		111290	111310	225		118483	115805
120		111291	111311	275		118486	115806
160		111292	111312	315		118487	115807
220		111293	111313	375		118489	115808
250		111294	111314	405		118490	115809
275		111295	111315	430		118491	115810
280		111296	111316	435		118492	115811
370		111297	111317	525		118495	115812
400		111298	111318	555		118496	115813
500		111299	111319	655		118497	115814
580		111300	111320	735		118498	115815
670		111301	111321	825		118499	115816
870		14	111302	111322		1025	8
1120	111303		111323	1275	118461	115818	
1270	111304		111324	1425	118462	115819	
1470	111305		111325	1625	118463	115820	
1670	111306		111326	1825	118464	115821	
1870	111307		111327	2025	118465	115822	

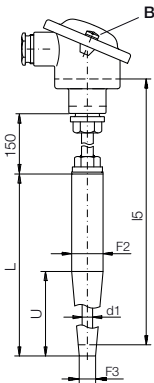

**T21.U.7**

mit Schutzrohr Form 4 nach DIN 43772, 1.4571  
with thermowell form 4 DIN 43772, 316Ti  
avec doigt de gant forme 4 selon DIN 43772, Z6 CNDT 17-12

T21.U.7 DIN 43767						Messeinsatz Measurig inserts Eléments de rechange				
Form Design Forme	U	L	F2	F3	Bestell-Nr. Order-N° N° de commande		l5	d1	Bestell-Nr. Order-N° N° de commande	
	mm				1xFe-CuNi -200...+600°C	1xNiCr-Ni -200...+800°C	mm		1xFe-CuNi -200...+600°C	1xNiCr-Ni -200...+800°C
4	65	140			111207	111211	315	6	118487	115807
	125		24	12,5	111208	111212			118489	115808
	65	200			111209	111213	375		118489	115808
	125	255	26	15,0	111210	111214	430	8	118504	416479
					111333	111335			118506	416480
					111334	111336			435	6

