

Druckausgleichsventile für Differenzdruckmessgeräte

Pressure equalising valves for differential pressure gauges

Robinets d'équilibre de pression pour manomètres différentiels

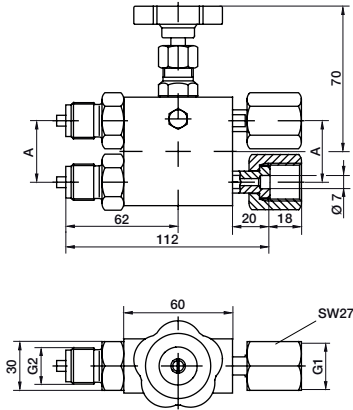

Differenzdruckmessgerät
Differential pressure gauge
Manomètre pour pression différentielle

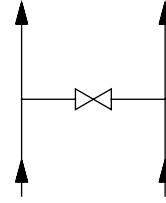

Prozess
process
procédé

Einfachventil One-way valve manifold Robinets simples

Bestell-Nr. Order N° N° de commande			Gewinde thread raccord		mm	T_{max} °C	PN	DN	kg
Messing brass laiton	Stahl steel acier	1.4571 316Ti Z6CNDT17-12	G1	G2	A				
402 289	-	402 290	G 1/2	G 1/2 B	34	100	400	3,5	0,60

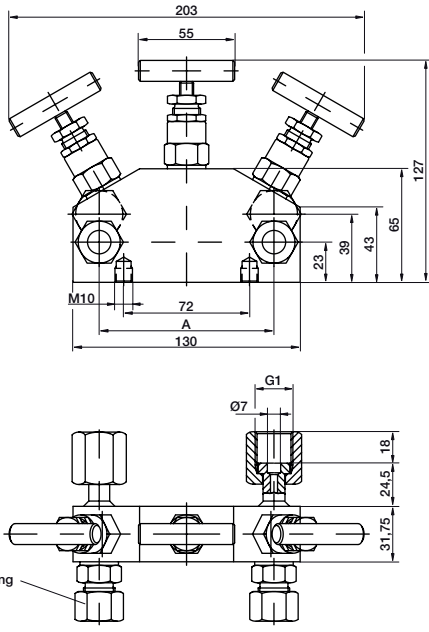

Differenzdruckmessgerät
Differential pressure gauge
Manomètre pour pression différentielle

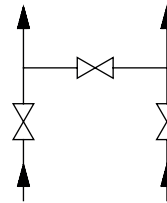

Prozess
process
procédé

Dreifachventil Three-way valve manifold Robinets triples

Bestell-Nr. Order N° N° de commande			Gewinde thread raccord		mm	T_{max} °C	PN	DN	kg
Messing brass laiton	Stahl steel acier	1.4571 316Ti Z6CNDT17-12	G1	Schneidring-Rohrverschraubung Cutting ring pipe screw-joints Raccord vissé de bicône	A				
-	409 262	401 411	G 1/2	G 3/8 Ø12 mm	37	100	400	4	0,90

Stand: 24. 10. 2023